

Application of the Direct Optimized Probabilistic Calculation

Martin Krejsa

Department of Structural Mechanics, Faculty of Civil Engineering, VSB - Technical University Ostrava, Ludvika Podeste 1875/17, 708 33 Ostrava - Poruba, Czech Republic, martin.krejsa@vsb.cz .

Abstract. The Direct Optimized Probabilistic Calculation method - DOProC - deals with probabilistic tasks where certain input quantities are of a random nature. DOProC is typically used in probabilistic reliability assessment of load carrying structures. DOProC can be also employed in probabilistic designs of structural elements with the specified reliability. In many cases, this calculation method is very efficient and provides accurate estimates of resulting probabilities.

DOProC has been successfully applied, among others, in the probabilistic calculation of fatigue cracks in steel structures and bridges which are subject to cyclical loads. The software used for that purpose, FCProbCalc, makes it possible to monitor efficiently and operatively development of fatigue damage to the structure and to specify times for service inspection. This means, the structure is compliant and well suited for operation in terms of fatigue damage. The methods and application can considerably improve estimation of maintenance costs for the structures and bridges subject to cyclical loads.

Keywords: Direct Optimized Probabilistic Calculation; DOProC; Safety Margin; Probability of Failure; Fatigue Crack Propagation; Inspection of Structure; Random Variable.

1. Introduction

Many calculation methods exist now for the designing and reliability assessment of load carrying structures and elements with the specified reliability. Those methods are based on the probability theory and mathematic statistics. They have been becoming more and more popular. The methods which are referred to as probabilistic or stochastic make it possible to analyze safety margin Z defined by a calculation model where at least some input quantities are of a random nature (Rackwitz et al., 1978). The calculation procedures contribute to a qualitatively higher level of the reliability assessment and, in turn, higher safety of those who use the buildings and facilities (Melchers, 1994).

The most frequently used and most numerous group of the computational method comprises the simulation methods which are based on the popular simulation technique - Monte Carlo (Bjerager, 1988; Hurtado et al., 1998) or any advanced or stratified simulation methods, for instance, Adaptive Sampling (Bucher, 1988), LHS (Helton et al., 2003; Olsson et al., 2003) and Importance Sampling. Eurocodes which are in force now mention the application of approximation methods FORM and SORM types (Der Kiureghian et al., 1998; Zhao et al., 2001) which are used mostly for calibration of partial factors. Those methods are also used in rather complex software applications based on Finite Elements Methods (FEM) (Vanmarcke et al., 1986; Reh et al., 2006; Stefanou, 2009).

The probabilistic approach to the assessment and designing of the structures has started appearing in practice recently only (Bergmeister et al., 2009). The pre-requisite is, however, a sufficient database of input

quantities including the experience from practical operation because many input quantities cannot be based on models and laboratory measurements only (this being the case, for instance, of geotechnics). Those computational methods are used, in particular, when designing the load-carrying systems for civil engineering structures and bridges (Kala, 2005; Krivy et al., 2007), where degradation processes in structures can be also taken into account (Konecny et al., 2007; Straub, 2009). It is possible to carry out the Performance-Based Design of structures which consider utility values such as durability, fire resistance, insulation or seismic resistance (Kralik et al., 2009; Teply et al., 2010). The probabilistic approach is used also in risk engineering (Kubecka, 2010). Stochastic models are being developed which describe interaction of building structures with subsoil or which taken into account undermining effects (Marschalko et al., 2011).

This paper describes the use of the original method and method which is under development now: the Direct Optimized Probabilistic Calculation (in short "DOProC") uses a purely numerical approach without any simulation techniques. This provides more accurate solutions to probabilistic tasks, and, in some cases, to considerably faster completion of computations. Such solution entails a small numerical error only and minor inaccuracies, the reason being discretizing of input and output quantities. In case of the probabilistic assessment of the reliability of structures, DOProC expresses directly the probability of failure p_f , which can be compared with the design value of nominal failure probability p_d , defined in standards and regulations in force. Where the failure probability p_f is zero (the structure is excessively reliable) or equal to one (the input quantities in any combination result in a failure), DOProC estimates the result immediately and no probabilistic calculations are needed anymore. In this case, DOProC method represents a very suitable and highly efficient solution (Krejsa, 2011).

Theoretical background of DOProC was described in detail in many publications (Janas et al., 2009). DOProC can be used now to solve efficiently a number of probabilistic computations. It has been used, for instance, in probabilistic assessment of combined load, reliability of cross-sections and systems consisting of statically determined or undetermined load carrying constructions, in probabilistic assessment of load carrying constructions which are subject to impact, in probabilistic analyses of steel-fibre reinforced concrete mixtures or in probabilistic assessment of reliability of anchored reinforcement or arc reinforcement in underground and long mine works with a special focus on anti-slipping properties.

DOProC has proved to be a good solution, among others, in probabilistic analyses of fatigue crack propagation in constructions subject to cyclical loads. Detailed methods with examples of the probabilistic assessment for a construction subject to fatigue load are available, a particular attention being paid to cracks from the edge and those from surface. Similarly to other probabilistic analyses, this information is used as a basis for proposing a system of inspections of the cyclic load construction (Moan, 2004; Chen et al., 2011; Li et al., 2011). In order to improve quality of probabilistic calculations, a special software - FCProbCalc - was developed. Using this software, the task can be solved flexibly in a user-friendly environment.

2. Direct Optimized Probabilistic Calculation

The Direct Optimized Probabilistic Calculation ("DOProC") has been under development since 2002. The calculation procedure for a certain task in DOProC is clearly determined by its algorithm, while Monte Carlo simulation methods generate calculation data for simulation on a random basis. The term in the name of the method - "the optimized" - is based on following facts: the number of variables that enter calculation of the failure probability p_f , computation is, however, limited by capabilities of the software to process the

application numerically. If there are too many random variables, the application is extremely time demanding - even if high-performance computers are used. Therefore, efforts have been made to optimize calculations in order to reduce the number of operations, keeping, at the same time, reliable calculation results. Currently, the DOProC along with the optimizing steps can address well several probabilistic tasks.

2.1. BASICS OF DOPROC METHOD

Similarly as with the other probabilistic methods, input random quantities in DOProC (such as the load, geometry, material properties, or imperfections) are described using the non-parametric (empirical) distribution in histograms. This technique can be also used for parametric divisions. The distribution is typically based on observations, being often long-lasting ones. A computational procedure is being developed now, the aim being to implement into DOProC the statistic dependence of input parameters, such as (Vorechovsky et al., 2009).

The basic computation algorithm of DOProC is based on general terms and procedures used in probabilistic theories. Let the histogram B be an arbitrary function f of histograms A_j where j ranges from 1 to n . Then:

$$B = f(A_1, A_2, A_3, \dots, A_j, \dots, A_n) . \quad (1)$$

Each histogram A_j consists of i_j interval where each interval is limited with $a_{j,i}$ from below and $a_{j,i+1}$ from above. This means, that for the interval $i_j = 1$, the values will be as follows:

$$a_{j,1} \leq a_j < a_{j,2} , \quad (2)$$

where

$$a_{j,2} = a_{j,1} + \Delta a_j , \quad (3)$$

where

$$\Delta a_j = \frac{a_{j,\max} - a_{j,\min}}{i_j} . \quad (4)$$

In i_j , following formula is valid:

$$a_{j,i} \leq a_j < a_{j,i+1} . \quad (5)$$

Let us express a_j in that interval as $a_j^{(ij)}$. Similar relations are valid for the B histogram. If there are i intervals, the values of the histogram in the i^{th} interval range from b_i to b_{i+1} , this means $b^{(i)}$. They can be expressed as follows:

$$b^{(i)} = f \left(a_1^{(i1)}, a_2^{(i2)}, \dots, a_j^{(ij)}, \dots, a_n^{(in)} \right) \quad (6)$$

for the specific combination of arguments: $a_1^{(i1)}, a_2^{(i2)}, \dots, a_j^{(ij)}, \dots, a_n^{(in)}$. The same value - $b^{(i)}$ - can be derived for other values too (or at least for some values too) - $a_j^{(ij)}$. If the potential combination of values $a_j^{(ij)}$ is marked as l , the following general formula can be derived:

$$b^{(i)} = f \left(a_1^{(i1)}, a_2^{(i2)}, \dots, a_j^{(ij)}, \dots, a_n^{(in)} \right)_l . \quad (7)$$

The probability p_{bl}^i of occurrence of $b^{(i)}$ is the product of $p_{aj}^{(ij)}$ (probabilities of occurrence of a_j^{ij} values). Then:

$$p_{bl}^i = \left(p_{aj}^{(i1)} \cdot p_{aj}^{(i2)} \cdot p_{aj}^{(i3)} \cdot \dots \cdot p_{aj}^{(ij)} \cdot \dots \cdot p_{aj}^{(in)} \right) \cdot \quad (8)$$

The probability of occurrence of all potential combinations $\left(a_1^{i1}, a_2^{i2}, \dots, a_j^{ij}, \dots, a_n^{in} \right)_l$ of f with the result of $b^{(i)}$ is:

$$p_b^{(i)} = \sum_{l=1}^l p_{bl}^{(i)} \cdot \quad (9)$$

The number of intervals i_j in each histogram A_j can vary similarly as the number of i intervals in the histogram B . The number of intervals is of utter importance for the number of needed numerical operations and required computing time. On top of this, the accuracy of the calculation depends considerably on the number of intervals.

Fig. 1 shows the numerical operations in the probabilistic calculations with two random quantities expressed in a histogram using the basic computational DOProC algorithm. In this case, two load components are combined or a sum of two histograms is used.

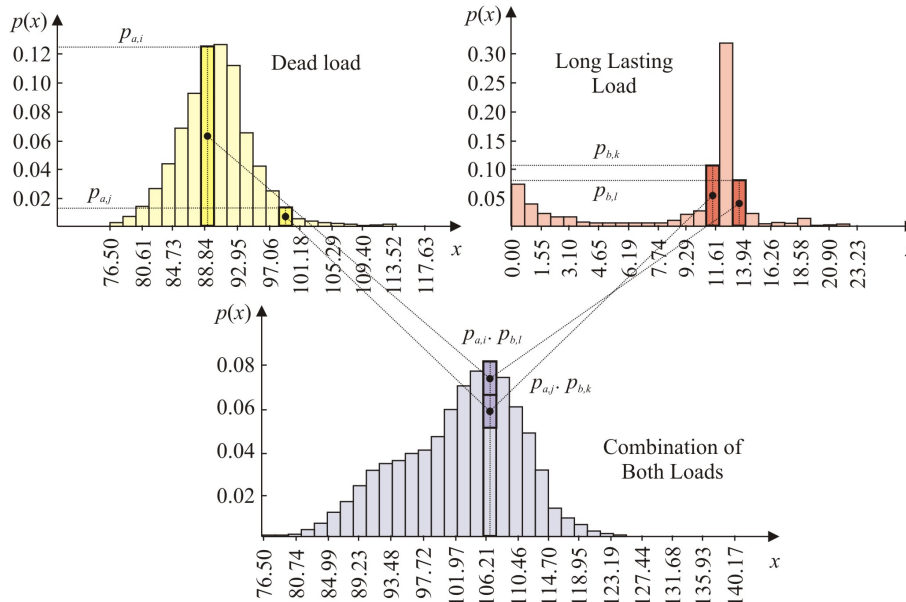

Figure 1. Principles of numerical operations with two histograms (the combination of dead load and long lasting load).

DOProC method is possible to use in ProbCalc (Janas et al., 2009; Janas et al., 2012) - software application which is still under development. It is rather easy and simple to implement quite a complicated analytical transformation model of a probabilistic task defined using a text-oriented editor, similar to Nessus software (Thacker et al., 2006) or Proban software (Tvedt, 2006). In more complex numerical calculation models,

there is a chance to use the procedure programmed by the user as DLL (with a dynamic library extension). More advanced user knowledge is required then to enter the probabilistic tasks in ProbCalc. It is essential to know, at least, general basics of algorithms because this influences the way of defining the computational model and selection of the best optimizing procedure. This weakness is removed if the application software is customized for a specific probabilistic task, this being, for instance, the case of FCProbCalc which is described in Chapter 3.3.

The computational complexity of DOProC is given, in particular, by:

- the number of random input quantities $i = 1 \dots N$,
- the number of histogram classes (intervals) for each random input quantity n_i ,
- complexity of the task (computational model),
- the algorithm used in the probabilistic calculation (the method used for definition of the computational model - in a ProbCalc text mode or using a dynamic library or application software).

2.2. USING DOPROC FOR CALCULATION OF FAILURE PROBABILITY

The construction should be designed in such a way so that the structural resistance R , would be higher than the load effects S . Considering all random phenomena in the load, manufacturing and installation inaccuracies and inaccuracies where the construction is used, the structural resistance R , and load effect S , should be regarded as random quantities - see Fig. 2. The both quantities need to be of the same dimension.

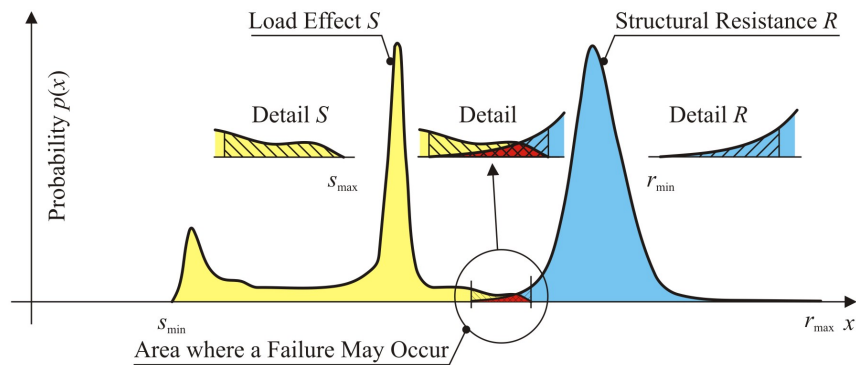

Figure 2. Probability density curves - load effect S , structural resistance R , and the area where a failure may occur.

The probabilistic reliability assessment is based on the reliability condition which can be expressed as follows:

$$Z = R - S \geq 0, \quad (10)$$

where Z is safety margin, R is the structural resistance and S is the load effect. If the reliability condition is not fulfilled, such situation is undesirable in terms of reliability - it is a failure when the load effect S exceeds the magnitude of the structural reliability R . The area where a failure may occur is shown in Fig. 2.

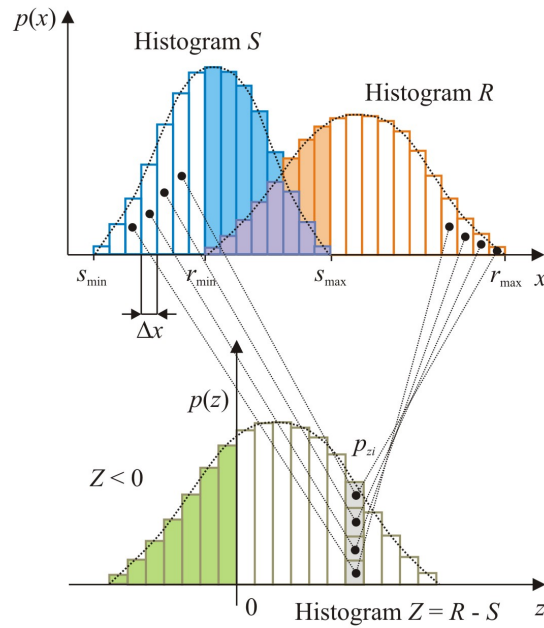

Figure 3. Basic approach to the calculation of the safety margin histogram Z , for two random variables using DOProC.

Fig. 3 shows the calculation of the safety margin Z , for two random quantities using the DOProC algorithm. The probability $p_{Z,i}$ in the i -class is the sum of products of the $p_{s,i}$ probabilities for s_i in i -classes of the S histogram and $p_{r,i}$ probability of r_i in i classes for the R histogram:

$$p_{Z,i} = \sum p_{s,i} \cdot p_{r,i} . \tag{11}$$

This results in the histograms for the safety margin Z , the final part of which gives the resulting probability failure p_f , which is compared then with the nominal probability of failure p_d .

If the Z histogram comprises n classes (intervals) with the Δz width, the resulting probability of failure p_f , is calculated then as the sum of probabilities $p_z^{(i=1..j)}$ in individual intervals (classes) where the safety margin is $Z < 0$ (this results from (10)). In the interval where the boundary values of the j class of the Z reliability histograms are within $z_j < 0 < z_{j+1}$, the distribution of probability $p_z^{(j)}$ should be divided proportionally into two parts. This means, the final probability of failure p_f is determined using Fig. 4 and equation:

$$p_f = \sum_{i=1}^{j-1} p_z^{(i)} + p_z^{(j)} \cdot \left(1 - \frac{z_j + \frac{\Delta z}{2}}{\Delta z} \right) = \sum_{i=1}^{j-1} p_z^{(i)} + p_z^{(j)} \cdot \left(\frac{1}{2} - \frac{z_j}{\Delta z} \right) . \tag{12}$$

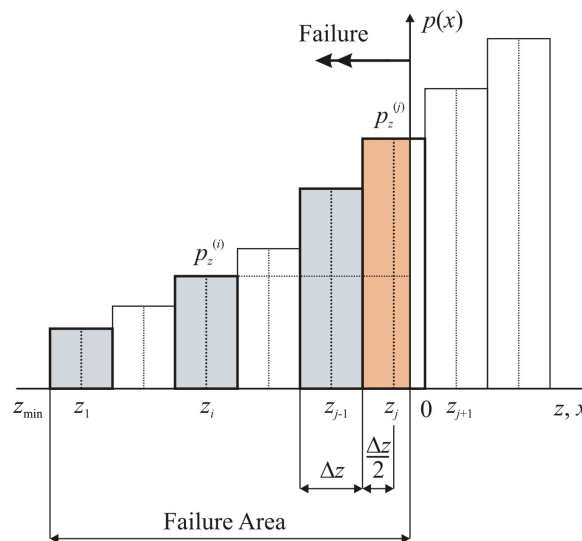

Figure 4. Calculation of the probability of failure p_f , from the histogram for the safety margin Z .

2.3. DOPROC OPTIMIZING TECHNIQUES

The purpose of the DOProc optimizing techniques is to minimize the computing time since the algorithm is limited to a certain extent, in particular, for extensive applications where too many simulations exist. If the optimizing techniques are used in DOProc, the failure probability p_f , can be determined in a real time. On top of this, results are reliable and accurate enough even in relatively demanding probabilistic tasks.

The optimizing techniques include:

- **Grouping of variable input quantities:** Grouping of the input quantities makes it possible to eliminate the number of input variable histograms. If possible, the resulting histogram is determined on the basis of the required mathematical operation. Then, the histogram is used for the probabilistic calculation of the model. This can considerably reduce the number of computational operations. This optimizing technique is used most frequently in calculations of the combined load or in a summary histogram which expresses impacts of wind loading by means of a "wind rose". If the grouping (this means, the creation of joint histograms of the input quantities) is possible and reliable, it is a very efficient and reasonable optimizing technique which reduces dramatically the number of computational operations in the probabilistic calculation.
- **Interval optimizing:** The objective of the interval optimizing is to minimize the number of classes used in the input quantity histograms. This reduces the number of computation operations and minimizes the machine time needed for the probabilistic calculation. A mandatory condition for this optimizing technique is the maintaining of sufficient accuracy of the required results. For this optimizing technique it is essential to make a sensitivity analysis and to check the influence of such reduction onto the result.
- **Zone optimizing:** In the zone analysis, each input quantity interval is divided into three zones. The first zone is always involved in creation of the probability of failure p_f , irrespective of values in other

histograms (the first zone is involved there, whatever combination of interval of the remaining input quantities is). The second zone may, but does not need to, be involved in the process (it is involved only in some combinations of intervals of the other input quantities), while the third zone is never involved there (when determining the probability of failure p_f , it is possible to omit this part of the histogram). If the zones are known, it is possible to calculate the probability of failure p_f very efficiently. Detailed information is available about the zone optimizing and practical aspects of this approach.

- **Trend optimizing:** Trend optimizing can be used as a supplement to the zone optimizing in the probabilistic calculations. In the zone optimizing technique is used, the calculation is carried out only for the zone #2. If a trend is found for the random variable (this means that the resulting positive value of the safety margin Z , increases with changes in the random variable) it does not make any sense to introduce other computational combinations. For such a quantity, the safety margin Z , cannot reach negative values and cannot influence the failure probability p_f . This means, it is possible to eliminate computational combinations and to keep only those which are really needed.
- **Grouping of partial computation results:** The purpose of the grouping of partial computational results is to decrease the number of computational operations during the assessment of the histograms of the quantities which are the result of the computational model. In case of the probabilistic reliability assessment, this group is defined by the safety margin Z , where the values entered pursuant to (10) are the calculated reliability of the structure R , and loading impacts S . In some cases, it is possible to enter directly the input quantity histogram into this group. (Such quantity can be the strength characteristic of the used material if the reliability assessment is done for the tension and the quantity is not involved in the computational model, or a limit deflection of the reliability assessment is based on the ultimate state of usability).
- **Computation parallelization:** The computation is carried out in several processors or core at the same time. The basic algorithm of DOProC is an optimum solution for the parallelism: partial results reached by multi core/processor computation are summed up in the final phase of the probabilistic calculation.
- **Combination of the aforementioned optimizing techniques:** Below is the recommended sequence of the optimizing techniques in DOProC:
 - Grouping: It should be used always, if possible.
 - Interval optimizing: It is recommended to minimize the number of histogram groups, particularly, when debugging the computational algorithm. Then, the number of the histogram classes should be optimized for specific results.
 - Other optimizing techniques which should be used, if possible and feasible in terms of complexity.

The optimizing techniques have been described in detail and implemented into ProbCalc and can be combined in the probabilistic calculation.

3. Using DOProC to calculate propagation of fatigue cracks

Probabilistic calculation of steel structures and bridges using DOProC method, leads to the probabilities of three basic random events in dependence on years of bridge's operation and fatigue crack propagation. On the basis of that calculation for each individual year, determined by analysis of reliability function, the

dependence of the failure probability on time of the bridge's operation is specified. When the limit reliability is known, it is possible to determine times of the structure's inspections (Krejsa, 2011).

3.1. BASICS OF PROPAGATION OF FATIGUE CRACKS

Reliability of the load-bearing structure has been significantly influenced by degradation resulting, in particular, from the fatigue of the basic materials. Whler's curves are used when designing such structures. The service life can be limited until a failure occurs. The failure is, however, very difficult to determine. For purposes of the modeling, the amplitude oscillation is considered to be constant, and a certain number of load cycles is taken into account. The method has been developed to provide procedures describing real conditions, all this making the work of design engineers easier. As fatigue cracks appear randomly on existing structures (in crane rails and bridges), it is believed that the designing method is imperfect to a certain extent (Fisher et al., 1998). Methods are under development that would be able to reveal potential defects and damage resulting from initiation cracks that accelerate considerably the propagation of fatigue cracks (Giner et al., 2008). Linear fracture mechanics is among alternative methods. Machinery experts have been dealing with such issues for many years. Results have been gradually taken over and implemented into designs of the loading structures in buildings. This approach is typically used for the determination of times of inspection and analyses of inspection results. If cracks are not found, a conditional probability exists that they might appear later on.

Attention is paid to fatigue damage of building steel structures and bridges where the acceptable fatigue (Anderson, 2005) crack size is assessed. The acceptable crack size plays a key role in degradation of an element dimensioned for an extreme loading combination that is exposed to variable operation loads. It represents a possible degradation of an element in an ultimate limit state that can be still monitored.

The outcome is procedures that should clarify currently acceptable methods used for the designing of the fatigue crack in the context of the safe service life and acceptable failure rate. A flange of the composite reinforced concrete bridge has been chosen for applications of the theoretical solution. This tension is exposed, in particular, to tension. Depending on location of an initial crack, the crack may propagate from the edge or surface. Regarding the frequency, weight and concentration of stresses, those locations rank among those with the major hazard of fatigue cracks appearing in the steel structures and bridges.

3.2. PROBABILISTIC APPROACH TO PROPAGATION OF FATIGUE CRACKS

Occurrence of initiation cracks and crack propagation in structures subject to fatigue load has been known for a long time. The process is closely connected with fabrication of the steel structures and, in particular, with creation of details which tend to be damaged by fatigue. The key difference is between initiation of cracks resulting from steelmaking inclusions and those created during fabrication of structural details. Regarding the former, it takes a long time until it reaches the surface, while the latter is at the surface from the beginning of the loading. Standardized approaches of previous EC standards suppose that surface cracks were not present there. The acceptable damage method which is described in the new standard admits random occurrence of surface cracks. The major difference is that a fatigue crack might not be fragile, but could be ductile. In real components of steel structures and bridges, the latter is more frequent than the former which is used in experimental measurements in processed small test-pieces. This fact is not a new phenomenon. It has been known for a long time and has been mentioned, for instance, by (Anderson, 2005).

During the designing, fabrication and processing of details, nobody, however, paid attention to random occurrence of initiation cracks from surface areas (from the surface or from the edge).

Three sizes are important for the characteristics of the propagation of fatigue cracks. These are the initiation size, the detectable size and the final size which occurs prior to failure caused by a fragile or ductile crack. The fatigue crack damage depends on a number of stress range cycles. This is a time factor in the course of reliability for the entire designed service life. In the course of time, the failure rate increases, while the reliability drops.

The topic is discussed in two levels that affect each other: the probabilistic solution to the propagation of the fatigue crack and uncertainties in determination of quantities used in the calculation. When investigating into the propagation, the fatigue crack that deteriorates a certain area of the structure components is described with one dimension only: a . In order to describe the propagation of the crack, the linear elastic fracture mechanics is typically used. It is based on the Paris-Erdogan law (Sanford, 2003):

$$\frac{da}{dN} = C \cdot (\Delta K)^m, \quad (13)$$

where C , m are material constants (Carpinteri et al., 2007), a is the crack size and N is the number of loading cycles.

The initial assumption is that the primary design should take into account the effects of the extreme loading resulting from the ultimate state of carrying capacity method. Then, the fatigue resistance should be assessed. This means, the reliability margin in the technical probability method is:

$$Z_{(R,S)} = RF = R - S, \quad (14)$$

where R is the random resistance of the element and S represents random variable effects of the extreme load.

When using (13), the condition for the acceptable crack length a_{ac} is:

$$N = \frac{1}{C} \int_{a_0}^{a_{ac}} \frac{da}{\Delta K^m} > N_{tot}, \quad (15)$$

where N is the number of cycles needed to increase the crack from the initiation size a_0 to the acceptable crack size a_{ac} , and N_{tot} is the number of cycles throughout the service life.

The equation for the propagation of the crack size (13) needs to be modified for this purpose. The state of stress near the crack face is described using ΔK (the stress intensity coefficient) which depends on the loading (bending, tension), size and shape of the fatigue crack, and geometry of the load-bearing component. If the $\Delta\sigma$ stress range and axial stress-load of the flange are constant, the following relation applies:

$$\Delta K = \Delta\sigma \cdot \sqrt{\pi a} \cdot F_{(a)}, \quad (16)$$

where $F_{(a)}$ is the calibration function which represents the course of propagation of the crack. After the change of the number of cycles from N_1 to N_2 , the crack will propagate from the length a_1 to a_2 . Having modified (13) and using (16), the following formula will be achieved:

$$\int_{a_1}^{a_2} \frac{da}{(\sqrt{\pi a} \cdot F_{(a)})^m} = \int_{N_1}^{N_2} C \cdot (\Delta\sigma)^m dN. \quad (17)$$

If the length of the crack a_1 equals to the initial length a_0 (this is the assumed size of the initiation crack in the probabilistic approach) and if a_2 equals to the final acceptable crack length a_{ac} (this is the acceptable crack size which replaces the critical crack size a_{cr} if the crack results in a brittle fracture), the left-hand side of the equation (17) can be regarded as the resistance of the structure $R_{(a_{ac})}$:

$$R_{(a_{ac})} = \int_{a_0}^{a_{ac}} \frac{da}{(\sqrt{\pi a} \cdot F_{(a)})^m} . \quad (18)$$

If the upper integration limit a_d is used, the resistance of the structure $R_{(a_{ad})}$ can be specified similarly. Similarly, it is possible to define the cumulated effect of loads that is equal to the right side (randomly variable effects of the extreme load) (17):

$$S = \int_{N_0}^N C \cdot (\Delta\sigma)^m dN = C \cdot (\Delta\sigma)^m \cdot (N - N_0) , \quad (19)$$

where N is the total number of oscillations of stress peaks ($\Delta\sigma$) for the change of the length from a_0 to a_{ac} , and N_0 is the number of oscillations in the time of initialization of the fatigue crack (typically, the number of oscillations is zero).

It is possible to define a reliability function RF :

$$RF(\mathbf{x}) = R_{(a_{ac})} - S_{(N)} . \quad (20)$$

where \mathbf{X} is a vector of random physical properties such as mechanical properties, geometry of the structure, load effects and dimensions of the fatigue crack.

The analysis of the reliability function (20) gives a failure probability p_f :

$$p_f = P(RF(\mathbf{x}) < 0) = P(R_{(a_{ac})} < S_{(N)}) . \quad (21)$$

3.3. APPLYING THEORETICAL APPROACH TO PROPAGATION OF FATIGUE CRACKS IN FCPROBCALC

A tension flange has been chosen for applications of the theoretical solution suggested in the studies (Tomica et al., 2007). Depending on location of an initial crack, the crack may propagate from the edge or from the surface (see Fig. 5). Regarding the frequency, weight and stress concentration, those locations rank among those with the major hazard of fatigue cracks appearing in the steel structures and bridges.

A flange without stress concentration is used for confronting the both cases depending on the location of the crack initiation. The cases are different in calibration functions $F_{(a)}$ - and in weakened surfaces which are appearing during the crack propagation.

3.3.1. Probabilistic calculation of fatigue cracks propagating from the edge

For the crack propagating from the edge, the calibration function is:

$$F_{(a)} = 1.12 - 1.39 \cdot \frac{a}{b} + 7.32 \cdot \left(\frac{a}{b}\right)^2 - 13.8 \cdot \left(\frac{a}{b}\right)^3 + 14.0 \cdot \left(\frac{a}{b}\right)^4 , \quad (22)$$

where a is the length of the crack and b is the width of the flange (Janssen et al., 2002); (see Fig.5).

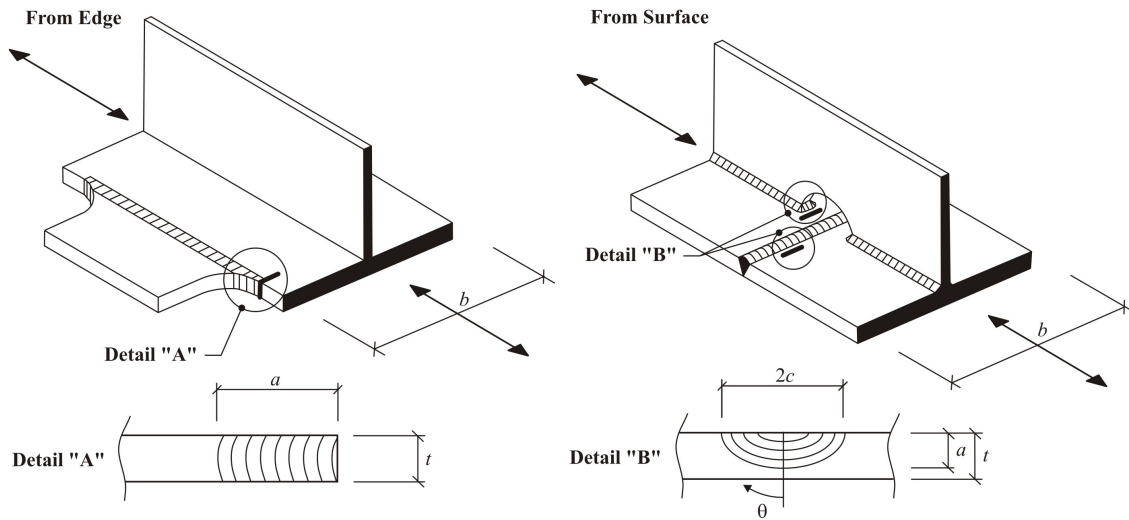

Figure 5. Characteristic propagation of cracks from the outer edge (left) and from the surface (right).

The acceptable crack size a_{ac} can be described then by a formula resulting from the deduced weakening of the cross-section area of the flange:

$$a_{ac} = b \cdot \left(1 - \frac{\sigma_{max}}{f_y} \right). \quad (23)$$

3.3.2. Probabilistic calculation of fatigue cracks propagating from the surface

A similar approach can be used to determine the acceptable size of a crack propagating from the surface. The bending component can be neglected for welded steel two-axis symmetric I-profiles where the fatigue crack appears in the lower tension flange. The flange is loaded only by the normal stress resulting from the axial load - tension: $\sigma_m = \sigma$.

It is rather difficult to deduce analytically the acceptable size of the crack propagating from the surface. In accordance with (Krejsa et al., 2010), the shape is replaced with a semi-elliptic curve where the ellipsis axes are a (the crack depth) and c (a half of the crack width) - see Fig. 5. The area of the surface crack depends on the number of N loading cycles and is described by the following formula:

$$A_{cr(N)} = \frac{1}{2} \cdot \pi \cdot a_N \cdot c_N. \quad (24)$$

During propagation of the fatigue crack from the surface, it is not enough to monitor only one crack size (which would be sufficient, for instance, for a crack propagating from the edge). In that case, the crack size needs to be analyzed for directions of the both semi-axes: a and c . The propagation of the fatigue crack from the surface in the a direction depends on the propagation in the c direction. Crack velocity propagation is

described by (13). In (Krejjsa et al., 2010) there is a formula for calculation of the crack depth Δa as a result of an increased width of the Δc crack:

$$\Delta a = \left\{ \frac{1}{\left[1.1 + 0.35 \cdot \left(\frac{a}{t} \right)^2 \cdot \sqrt{\frac{a}{c}} \right]} \right\}^m \cdot \Delta c . \quad (25)$$

The crack sizes for a and c are during the propagation limited by upper limit values:

$$2 \cdot c \leq 0,4 \cdot b_f \quad a \leq 0,8 \cdot t_f , \quad (26)$$

If these upper limit values are exceeded, the fatigue crack propagates differently. (Krejjsa, 2011) gives also the formula for the mutual dependence of the sizes in a and c :

$$c = 0.3027 \cdot \frac{a^2}{t} + 1.0202 \cdot a + 0.00699 \cdot t . \quad (27)$$

When determining the acceptable crack size, a modified relation (24) using (25) and (27), should be taken as a basis. After modification:

$$\sigma_{\max} \cdot \frac{b_f t_f}{b_f t_f - \frac{1}{2} \cdot \pi a \cdot \left(0.3027 \cdot \frac{a^2}{t_f} + 1.0202 \cdot a + 0.00699 \cdot t_f \right)} \leq f_y , \quad (28)$$

It is difficult to describe the a crack size directly explicitly. In order to calculate the acceptable crack size a_{ac} , it is necessary to use a numerical iteration approach where restrictions resulting from (28) should be taken as a basis.

3.3.3. Determination of inspections of structures subject to fatigue

Because it is not certain in the probabilistic calculation whether the initiation crack exists and what the initiation crack size is and because other inaccuracies influence the calculation of the crack propagation, a specialized inspection is necessary to check the size of the measureable crack in a specific period of time. The acceptable crack size influences the time of the inspection. If no fatigue cracks are found, the analysis of inspection results gives conditional probability during occurrence.

While the fatigue crack is propagating, it is possible to define following random phenomena that are related to the growth of the fatigue crack and may occur in any time t during the service life of the structure. Then:

- $U_{(t)}$ **phenomenon:** No fatigue crack failure has not been revealed within the t -time and the fatigue crack size $a_{(t)}$ has not reached the detectable crack size a_d . This means:

$$a_{(t)} < a_d , \quad (29)$$

- $D_{(t)}$ **phenomenon:** A fatigue crack failure has been revealed within the t -time and the fatigue crack size $a_{(t)}$ is still below the acceptable crack size a_{ac} . This means:

$$a_d \leq a_{(t)} < a_{ac} , \quad (30)$$

- $F_{(t)}$ **phenomenon:** A failure has been revealed within the t -time and the fatigue crack size $a_{(t)}$ has reached the acceptable crack size a_{ac} . This means:

$$a_{ac} < a_{(t)} . \quad (31)$$

If the crack is not revealed within the t -time, this may mean that there is not any fatigue crack in the construction element. This might be an initiative phase of nucleation of the fatigue crack (when a crack appears in the material) and this phenomenon is not taken into account in the fracture mechanics. Even if the fatigue crack is not revealed it is likely that it exists but the fatigue crack size is so small that it cannot be detected under existing conditions.

Using the phenomena above, it is possible to define probability for their occurrence in any t -time. Those three phenomena cover the complete spectrum of phenomena that might occur in the t -time. This means:

$$P(U_{(t)}) + P(D_{(t)}) + P(F_{(t)}) = 1 . \quad (32)$$

The probabilistic calculation is carried out in time steps where one step typically equals to one year of the service life of the construction. When the failure probability $P(F_{(t)})$ reaches the nominal failure probability p_d , an inspection should be carried out in order to find out fatigue cracks, if any, in the construction element. The inspection provides information about real conditions of the construction. Such conditions can be taken into account when carrying out further probabilistic calculations. The inspection in the t time may result in any of the three mentioned phenomena. Using the inspection results for the t time, it is possible to define the probability of the mentioned phenomena in another times: $T > t_I$. For that purpose, the conditional probability should be taken into consideration.

3.3.4. Using FCProbCalc for the probabilistic calculation of fatigue cracks propagating

FCProbCalc (Fig. 6) was developed using the aforementioned techniques. By means of FCProbCalc, it is possible to carry out the probabilistic calculation of propagation of fatigue cracks in a user friendly environment. The cracks propagate from edges or surface and the goal of the probabilistic calculation is to determine the time for the first inspection which focuses on damage to the structure.

Both deterministic and stochastic approaches are used for input values in the probabilistic calculation. In (Krejsa et al., 2010), the probabilistic assessment was carried out for a detail of a highway bridge made from steel/concrete which tends to suffer from fatigue damage. Real input values were used there: the geometric shape in the specified place, the yield stress f_y , the nominal designed stress of extreme impacts σ , material constants m and C , as well as constant stress oscillation $\Delta\sigma$. The source of the oscillation value was measurements of the response in regular operation. Other input data include the random quantities - they are expressed by means of the parametric distribution and were rather inaccurate if used as the input values. These values include the expected length of the detectable crack $a_d = 10$ mm, the number of load cycles per year $N = 1.10^6$ and, in particular, the size and exact location of the initiation crack a_0 . Considering the detail of connection of the flange plate, it was decided to choose the mean value of $a_0 = 0.2$ mm with lognormal distribution. For all input data see Table I (the random quantities with variable values) and Table II (the deterministic quantities). The required reliability is expressed in the technical practice as a reliability index $\beta = 2$, that corresponds to the failure rate of $p_d = 0.02277$.

Using FCProbCalc it is possible to specify for a certain time interval the load effect S (Fig. 7), resistance of the structure $R(a_d)$ (Fig. 8) and $R(a_{ac})$ (Fig. 9), as well as probability of elementary phenomena U , D

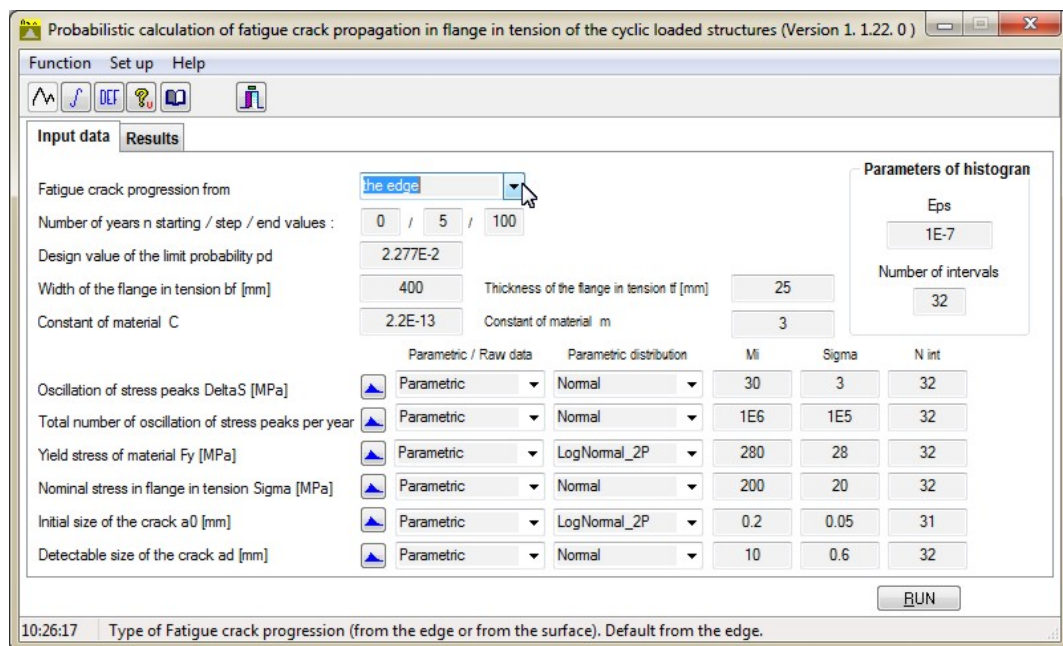

Figure 6. FCProbCalc desktop - entry of input quantities.

Table I. Overview of variable input quantities expressed in a histogram with parametric distribution of probabilities.

Quantity	Type	Mean value	Standard deviation
Oscillation of stress peaks $\Delta\sigma$ [MPa]	Normal	30	3
Total number of oscillation of stress peaks per year N [-]	Normal	10^6	10^5
Yield stress f_y [MPa]	Lognormal	280	28
Nominal stress in the flange plate σ [MPa]	Normal	200	20
Initial size of the crack a_0 [mm]	Lognormal	0.2	0.05
Smallest detectable size of the crack a_d [mm]	Normal	10	0.6

and F (Fig. 10) which are the source information for determination of the time of inspection which focuses on fatigue damage to the construction (Fig. 11).

The probabilistic calculation in FCProbCalc has proved, among others, that the propagation of the fatigue crack from the surface is considerably slower than that from the edge. The calculated time for the first inspection of the bridge is the 55th year of operation for the fatigue crack propagating from the edge and 113th year of operation for the fatigue crack propagating from the surface. This means the former propagation rate is approximately twice slower than the latter one.

Table II. Overview of input quantities expressed in a deterministic way.

Quantity	Value
Material constant m	3
Material constant C	$2.2 \cdot 10^{13}$
Width of the flange plate b_f [mm]	400
Thickness of the flange plate t_f [mm]	25
Nominal probability of failure p_d	0.02277

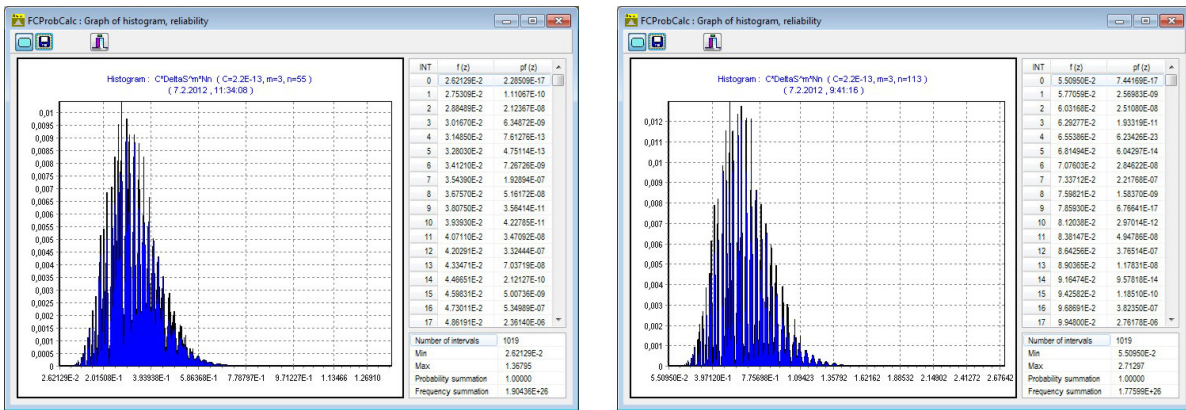

Figure 7. FCProbCalc program output: histograms for the load effects S after 55 years (left) and 113 years (right) of operation.

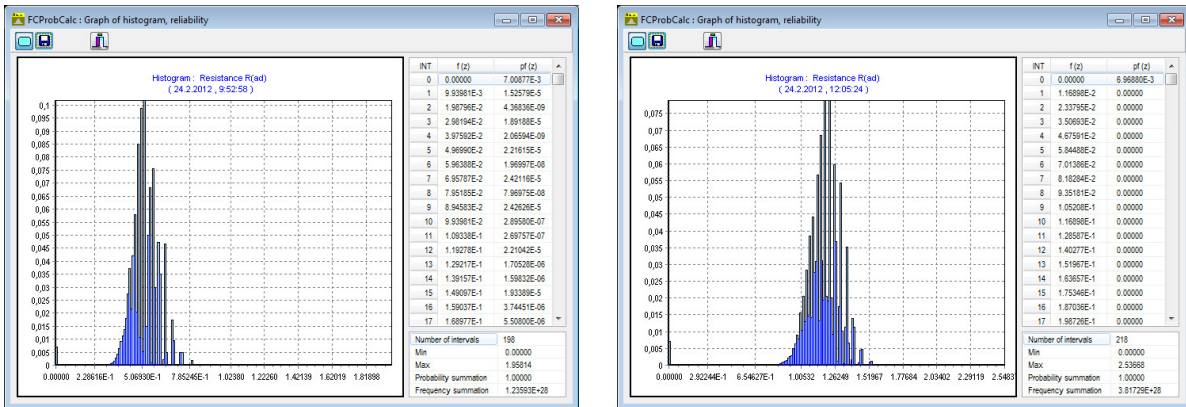

Figure 8. FCProbCalc program output: Resulting histogram of the structural resistance $R(a_d)$ for propagation of fatigue crack from the edge (left) and from the surface (right).

Application of the Direct Optimized Probabilistic Calculation

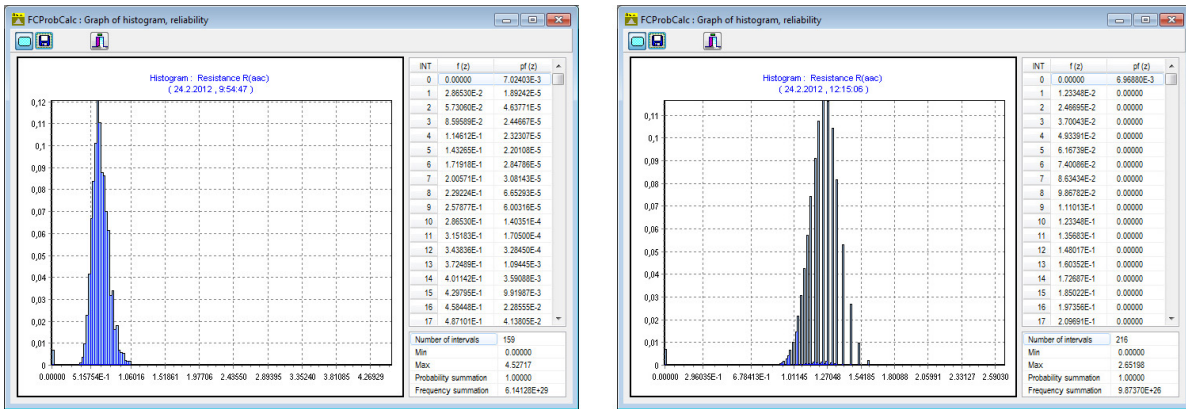

Figure 9. FCProbCalc program output: Resulting histogram of the structural resistance $R(a_{ac})$ for propagation of fatigue crack from the edge (left) and from the surface (right).

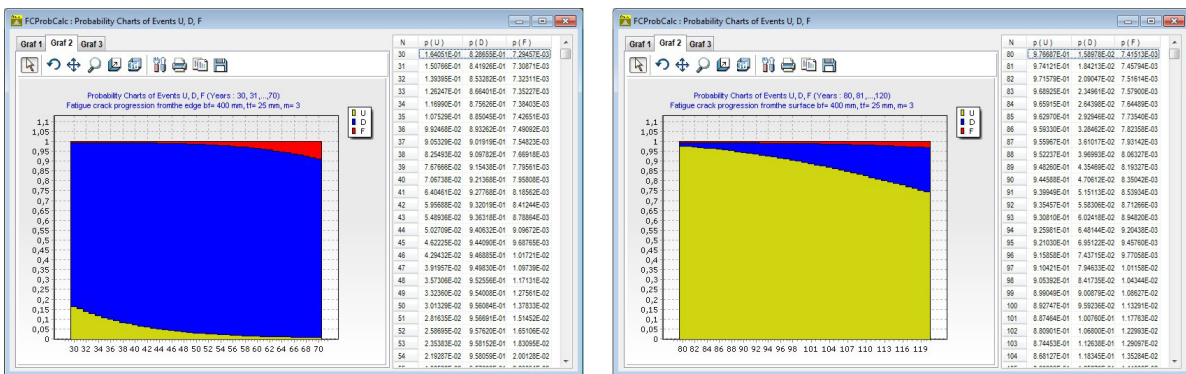

Figure 10. FCProbCalc program output: Probabilities of the phenomena U , D and F for the propagation of fatigue crack from the edge (30 to 70 years of operation, left) and for the propagation of fatigue crack from the surface (80 to 120 years of operation, right).

4. Conclusions

This paper discusses development of probabilistic methods and application of the probabilistic methods in assessment of reliabilities of structures. The basics of this work are a detailed overview of the Direct Optimized Probabilistic Calculation (DOProC) which can be used now in many probabilistic calculations. DOProC appears to be a very efficient tool that results in the solution affected by a numerical error and by an error resulting from the discretizing of the input and output quantities only. The biggest weakness of DOProC is a considerable increase in the machine time for probabilistic operations and rather many random variables in the computational model. The maximum number of the random variables depends on complexity of the computational model. What is also important is whether it is possible to use any of the described optimized steps.

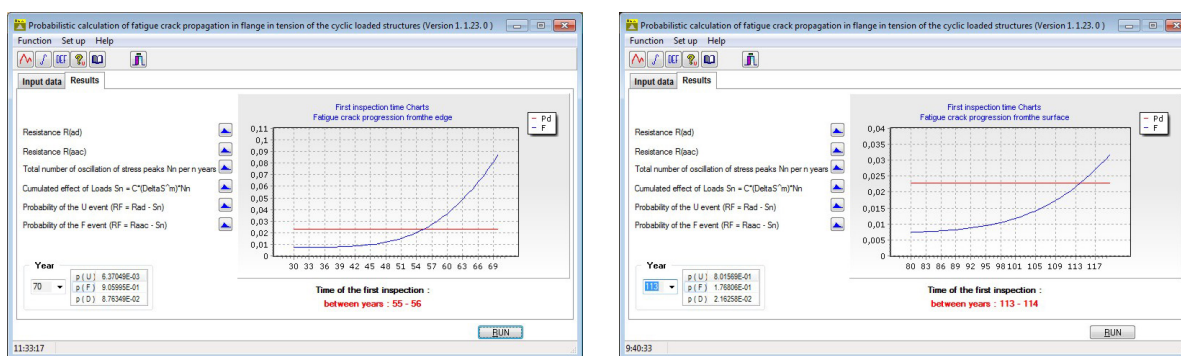

Figure 11. FCProbCalc program output: failure probability p_f , depending on the years of operation for the propagation of fatigue crack from the edge (30 to 70 years of operation, left) and for the propagation of fatigue crack from the surface (80 to 120 years of operation, right).

Examples of applications of the probabilistic method DOProC described in specialized papers and mentioned in this work should provide general information about this probabilistic method. DOProC seems to be a good choice not only for reliability assessment tasks but also for other probabilistic calculations. For instance, theoretical information and practical guidelines are available to the probabilistic assessment of propagation of fatigue cracks from the surface and edge, a particular attention being paid to the maximum permissible dimension and proposed system of regular inspections of the structure.

FCProbCalc was used for the probabilistic assessment of fatigue damage to a bridge structure where cracks were propagating from both the surface and edge. Times were specified for inspections of the bridge structure, where the purpose was to monitor occurrence of certain fatigue cracks. The comparison proved that velocity of propagation of the fatigue crack from the surface is considerably slower than that from the edge.

A relatively complex algorithm in DOProC requires good theoretical knowledge and practical computing skills of the user. It is essential to know, at least, general basics of algorithms because this influence the way of defining the computational model and selection of the best optimizing procedure. This weakness is removed if the application software is customized for a specific probabilistic task, this being, for instance, the case of FCProbCalc.

It should be pointed out that DOProC still provides many other options to be used. What is worth being investigated further is the use of statistically dependent input quantities with direct entries in the computational algorithm, assessment of reliability of structural systems and development of numerical procedures which will make the application of DOProC in matrix calculations more efficient.

Appendix

For a lite version of FCProbCalc and for other software products based on DOProC method please visit web pages <http://www.fast.vsb.cz/popv> (Janas et al., 2012).

Acknowledgements

The paper was published thanks to the financial support granted to the project "Mathematics for the 21st century engineers – innovating the teaching of mathematics in technical schools in the context of a fast developing information and technical society". The project registration number is CZ.1.07/2.2.00/07.0332. Universities responsible for the project are the Technical University of Ostrava and West Bohemia University in Pilsen.

References

- Anderson, T. L. *Fracture mechanics: fundamentals and applications*. Third edition, CRC Press, Taylor & Francis Group, Boca Raton, Florida, 2005. ISBN 0-8493-1656-1.
- Bergmeister, K., Novak, D., Pukl, R. and V. Cervenka V. Structural and Reliability Analysis for Existing Engineering Structures, Theoretical Background. *Structure and Infrastructure Engineering*, vol. 5, issue 4, pp 267–275 (9 p), DOI 10.1080/15732470601185612, 2009.
- Bjerager, P. Probability Integration by Directional Simulation. *Journal of Engineering Mechanics – ASCE*, vol. 114, issue 8, pp 1285–1302 (18 p), 1988.
- Bucher, C. G. Adaptive Sampling – an Iterative Fast Monte-Carlo Procedure. *Structural Safety*, vol. 5, issue 2, pp 119–126 (8 p), DOI 10.1016/0167-4730(88)90020-3, 1988.
- Carpinteri, A. and M. Paggi. Self-similarity and crack growth instability in the correlation between the Paris' constants. *Engineering Fracture Mechanics*, vol. 74, issue 7, pp 1041–1053 (13 p), DOI 10.1016/j.engfracmech.2006.12.007, May 2007.
- Chen, N. Z., Wang, G. and C. G. Soares. Palmgren-Miner's rule and fracture mechanics-based inspection planning. *Engineering Fracture Mechanics*, vol. 78, issue 18, pp 3166–3182 (17 p), DOI 10.1016/j.engfracmech.2011.08.002, December 2011.
- Der Kiureghian, A. and T. Dakessian. Multiple Design Points in First and Second-Order Reliability. *Structural Safety*, vol. 20, issue 1, pp 37–49 (13 p), DOI 10.1016/S0167-4730(97)00026-X, 1998.
- Fisher, J. W., Kulak, G. L. and I. F. C. Smith. *A Fatigue Primer for Structural Engineers*. National Steel Bridge Alliance, U.S.A., May 1998.
- Giner, E., Sukumar, N., Denia, F. D. and F. J. Fuenmayor. Extended finite element method for fretting fatigue crack propagation. *International Journal of Solids and Structures*, vol. 45, issue 22–23, pp 5675–5687 (13 p), DOI 10.1016/j.ijsolstr.2008.06.009, November 2008.
- Helton, J. C. and F. J. Davis. Latin Hypercube Sampling and the Propagation of Uncertainty in Analyses of Complex Systems. *Reliability Engineering & System Safety*, vol. 81, issue 1, pp 23–69 (47 p), DOI 10.1016/S0951-8320(03)00058-9, 2003.
- Hurtado, J. E. and A. H. Barbat. Monte Carlo Techniques in Computational Stochastic Mechanics. *Archives of Computational Methods in Engineering*, vol. 5, issue 1, pp 3–29 (27 p), DOI 10.1007/BF02736747, 1998.
- Janas, P., Krejsa, M. and V. Krejsa. *ProbCalc Software and DOProC Method*. Web pages. [on-line]. <http://www.fast.vsb.cz/popvz>. VSB – Technical University Ostrava, 2012.
- Janas, P., Krejsa, M. and V. Krejsa. Structural Reliability Assessment using a Direct Determined Probabilistic Calculation. *Proceedings of the 12th International Conference on Civil, Structural and Environmental Engineering Computing*, Civil-Comp Press, Stirlingshire, Scotland. Paper 79, 2009, ISBN 978-1-905088-31-7.
- Janas, P., Krejsa, M. and V. Krejsa. Using the Direct Determined Fully Probabilistic Method for determination of failure. *Proceedings of the European Safety and Reliability Conference, Esrel 2009*. Taylor & Francis Group, London, 2010, ISBN 978-0-415-55509-8 (set of 3 volumes + CD-ROM), ISBN 978-0-203-85975-9 (e-book).
- Janssen, M., Zuidema, J. and R. J. H. Wanhill. *Fracture Mechanics*. Second edition, Delft University Press, 2002. ISBN 90-407-2221-8.
- Kala, Z. Sensitivity Analysis of the Stability Problems of Thin-Walled Structures. *Journal of Constructional Steel Research*, vol. 61, issue 3, pp 415–422 (8 p), DOI 10.1016/j.jcsr.2004.08.005, 2005.
- Konecny, P., Tikalsky, P. J. and D. G. Tepke. Performance Evaluation of Concrete Bridge Deck Affected by Chloride Ingress. *Transportation Research Record*, issue 2028, pp 3–8 (6 p), DOI 10.3141/2028-01, 2007.

- Kralik, J. and J. Kralik. Seismic Analysis of Reinforced Concrete Frame–Wall Systems Considering Ductility Effects in Accordance to Eurocode. *Engineering Structures*, vol. 31, issue 12, pp 2865–2872 (8 p), DOI 10.1016/j.engstruct.2009.07.029, 2009.
- Krejsa, M. and V. Tomica. Calculation of Fatigue Crack Propagation Using DOProC Method. *Transactions of the VSB – Technical University of Ostrava*, no.1, 2010, vol.X, Civil Engineering Series, paper #11 (9 p), DOI 10.2478/v10160-010-0011-6. Publisher Versita, Warsaw, ISSN 1213-1962 (Print) ISSN 1804-4824 (Online).
- Krejsa, M. and V. Tomica. Determination of Inspections of Structures Subject to Fatigue. *Transactions of the VSB – Technical University of Ostrava*, no.1, 2011, vol.XI, Civil Engineering Series, paper #7 (11 p), DOI 10.2478/v10160-011-0007-x. Publisher Versita, Warsaw, ISSN 1213-1962 (Print) ISSN 1804-4824 (Online).
- Krejsa, M. *Using DOProC Method for Structural Reliability Assessment*. Habilitation thesis, VSB – TU Ostrava, 2011. ISBN 978-80-248-2385-0.
- Krivy, V. and P. Marek. Probabilistic Design of Steel Frame Structures. *Stahlbau*, vol. 76, issue 1, pp 12–20 (13 p), DOI 10.1002/stab.200710003, 2007.
- Kubecka, K. Utilisation of Risk Analysis Methods in Decision – Making Process on Fitness of Rehabilitation. *Stavebnictv*, pp 26–31 (6 p), 2010. ISSN 1802-2030, EAN 977180220300501.
- Li, J., Peng, Y. B. and Chen J. B. Probabilistic Criteria of Structural Stochastic Optimal Controls. *Probabilistic Engineering Mechanics*, vol. 26, issue 2, pp 240–253 (14 p), DOI 10.1016/j.probingmech.2010.07.011, 2011.
- Marschalko, M., Yilmaz, I., Bednarik, M. and K. Kubecka. Variations in the building site categories in the underground mining region of Doubrava (Czech Republic) for land use planning. *Engineering Geology*, vol. 122, issue 3–4, pp 169–178 (10 p), DOI 10.1016/j.enggeo.2011.05.008, October 2011.
- Melchers, R. E. Structural System Reliability Assessment Using Directional Simulation. *Structural Safety*, vol. 16, issue 1–2, pp 23–37 (15 p), DOI 10.1016/0167-4730(94)00026-M, 1994.
- Moan, T. Reliability–based management of inspection, maintenance and repair of offshore structures. *Structure and Infrastructure Engineering*, vol. 1, issue 1, pp 33–62 (30 p), DOI 10.1080/15732470412331289314, Taylor & Francis Ltd., March 2005.
- Olsson, A., Sandberg, G. and O. Dahlblom. On Latin Hypercube Sampling for Structural Reliability Analysis. *Structural Safety*, vol. 25, issue 1, pp 47–68 (22 p), Article Number: PII S0167-4730(02)00039-5, DOI 10.1016/S0167-4730(02)00039-5, 2003.
- Rackwitz, R. and B. Fiessler. Structural Reliability Under Combined Random Load Sequences. *Computers & Structures*, vol. 9, issue 5, pp 489–494 (6 p), DOI 10.1016/0045-7949(78)90046-9, 1978.
- Reh, S., Beley, J. D., Mukherjee, S. and E. H. Khor. Probabilistic Finite Element Analysis Using ANSYS. *Structural Safety*, vol. 28, issue 1–2, pp 17–43 (27 p), DOI 10.1016/j.strusafe.2005.03.010, 2006.
- Sanford, R. J. *Principles of Fracture Mechanics*. Pearson Education, Inc., U.S.A., 2003. ISBN 0-13-092992-1.
- Stefanou, G. The Stochastic Finite Element Method: Past, Present and Future. *Computer Methods in Applied Mechanics and Engineering*, vol. 198, issue 9–12, pp 1031–1051 (21 p). DOI 10.1016/j.cma.2008.11.007, 2009.
- Straub, D. Stochastic Modeling of Deterioration Processes through Dynamic Bayesian Networks. *Journal of Engineering Mechanics*. 2009. DOI 10.1061/(ASCE)EM.1943-7889.0000024.
- Teply, B., Vorechovska, D. and Z. Kersner. Performance-Based Design of Concrete Structures: Durability Aspects. *Structural Engineering and Mechanics*, vol. 35, issue 4, pp 535–538 (4 p), 2010.
- Thacker, B. H., Riha, D. S., Fitch, S. H. K., Huysse, L. J. and J. B. Fleming. Probabilistic Engineering Analysis Using the NESSUS software. *Structural Safety*, vol. 28, issue 1–2, pp 83–107 (25 p), 2006, DOI 10.1016/j.strusafe.2004.11.003.
- Tomica, V. and M. Krejsa. Optimal Safety Level of Acceptable Fatigue Crack. *Proceedings of 5th International Probabilistic Workshop*, Ghent, Belgium, 2007. Edited by L.Taerwe and D.Proske. (12 p). ISBN 978-3-00-022030-2.
- Tvedt, L. Proban - Probabilistic Analysis. *Structural Safety*, vol. 28, issue 1-2, pp 150-163 (14 p), 2006, DOI 10.1016/j.strusafe.2005.03.003.
- Vanmarcke, E., Shinoyuka, M., Nakagiri, S., Schueller, G. I. and M. Gtorigiu. Random – Fields and Stochastic Finite – Elements. *Structural Safety*, vol. 3, issue 3-4, pp 143–166 (24 p), DOI 10.1016/0167-4730(86)90002-0, 1986.
- Vorechovsky, M. and D. Novak. Correlation Control in Small-Sample Monte Carlo type simulations I: A Simulated Annealing Approach. *Probabilistic Engineering Mechanics*, vol. 24, issue 3, pp 452–462 (11 p), DOI 10.1016/j.probingmech.2009.01.004, 2009.
- Zhao, Y. G. and T. Ono. Moment Methods for Structural Reliability. *Structural Safety*, vol. 23, issue 1, pp 47–75 (29 p), DOI 10.1016/S0167-4730(00)00027-8, 2001.