

Experimental study on asphaltene precipitation induced by CO₂ flooding

DONG Zhao-xia*, WANG Jun, LIU Gang, LIN Mei-qin and LI Ming-yuan

¹ Enhanced Oil Recovery Research Institute, China University of Petroleum, Beijing 102249, China

² Beijing Key Laboratory for Greenhouse Gas Storage and Enhanced Oil Recovery, Beijing 102249, China

³ Key Laboratory of Enhanced Oil Recovery, CNPC, Beijing 102249, China

© China University of Petroleum (Beijing) and Springer-Verlag Berlin Heidelberg 2014

Abstract: The effects of CO₂ pressure, temperature and concentration on asphaltene precipitation induced by CO₂ were studied using a high-pressure vessel, interfacial tensiometer, Fourier transform infrared (FTIR) and drill core displacement experimental apparatus. The results indicated that the content of asphaltene in crude oil decreased, and the interfacial tension between a model oil and distilled water increased, with an increase of CO₂ pressure, decrease of temperature and increase of molar ratio of CO₂ to crude oil when CO₂ contacted crude oil in the high pressure vessel. The content of asphaltene in sweep-out oil and the permeability of test cores both also decreased with an increase of CO₂ flooding pressure. The main reason for changes in content of asphaltene in crude oil, in interfacial tension between model oil and distilled water and in the permeability of the test core is the precipitation of asphaltene which is an interfacially active substance in crude oil. Precipitation of asphaltene also blocks pores in the drill core which decreases the permeability.

Key words: CO₂ flooding, asphaltene precipitation, oil-water interfacial tension, core permeability

1 Introduction

CO₂ flooding is an effective method for geological sequestration of greenhouse gas and enhancing oil recovery. During the CO₂ flooding process, it becomes difficult for asphaltene to remain dissolved in crude oil, resulting in precipitation of asphaltene (Srivastava et al, 1999; Shen and Mullins, 1995). Different opinions exist about the form of asphaltene in crude oil, but the micelle model for asphaltene and resins has obtained general recognition (Chu et al, 2003). According to the colloid theory, asphaltene exists in crude oil in the form of dispersed colloid. Resin molecules are adsorbed on the surface of asphaltene molecule groups and a solvated layer is formed. Thus micelles, with asphaltene molecule groups as their kernels, are formed and dispersed in crude oil. The surface energy of the asphaltene molecule groups can be decreased significantly by the solvated layer, preventing asphaltene molecule groups from further association. With injected CO₂ dissolving in crude oil, CO₂ molecules can occupy the surface area of asphaltene molecule groups, and cause the concentration of resins on the surface to decrease. As a result the micelles are not formed as readily or the solvated layer of the micelles is not thick enough for their stability. Consequently asphaltene molecular groups will be further associated into bigger molecular groups and flocculation and precipitation of asphaltene occurs (Srivastava

et al, 1999). Research also shows that the precipitation of asphaltene can also be caused by the variation of reservoir pressure, temperature and oil composition (Li, 2006; Li et al, 2000; Lin, 2000). The external cause for asphaltene precipitation is the variation of reservoir pressure and temperature, while the variation of oil composition is the internal cause. The effects of these three factors are mainly on the variation of the asphaltene-dissolving capacity of crude oil. The reservoir rock and the composition of formation water also affect the precipitation of asphaltene (Kokal and Sayegh, 1995).

The serious precipitation of asphaltene would cause some problems, such as a decrease of reservoir permeability, reservoir damage and blockage of boreholes and pipes. In addition, because of asphaltene precipitated in the bed rock, the wettability can be reversed, so the oil recovery can be affected by the precipitation of asphaltene (Buckley, 1995; Kamath et al, 1993; Novosad and Costain, 1990; Becker et al, 1992; Leontaritis et al, 1992; Leontaritis and Mansoori, 1988). Under most conditions, the precipitated asphaltene can deposit on the surface of separators or other downstream equipment (Liu et al, 1999). Therefore, a lot of research is focused on the mechanism of asphaltene precipitation and the precipitation experiments investigating the CO₂ flooding process.

In this work, under different experimental conditions such as pressure, temperature and molar ratio, the interfacial tension between water and oil, and the content of asphaltene, oil components and elemental composition of Gudong crude

*Corresponding author. email: dzx@cup.edu.cn

Received April 17, 2013

oil (from the Gudong Oilfield, east China) before and after CO₂ injection were measured; The variation of the core oil permeability, and of the asphaltene content of produced oil, after CO₂ injection were also determined. Based on these results, the factors influencing precipitation of asphaltene during CO₂ flooding was investigated.

2 Experiments

2.1 Reagents and apparatus

CO₂ (mass fraction > 99.95%, provided by Beijing AP BAIF Gases Industry Co., Ltd., China); Gudong crude oil from the Gudong Oilfield, east China, with a viscosity of 232.0 mPa·s (50 °C) and the density of 0.9215 g/cm³ (50 °C). The permeability of the sand cores used is in the range of 0.22-0.24 μm²; refined kerosene (treated by silica gel adsorption); the interfacial tension between the refined kerosene and deionized water was 46 mN·m⁻¹; Cellulose membranes with a pore diameter of 0.45 μm, manufactured by Beijing Beihualiming Film Technology CO., Ltd., China; *n*-hexane and petroleum ether are analytically pure and purchased from Beijing chemical reagent factory, China; distilled water with a conductivity of 18 μΩ. Dataphysics SCAT Interface Tensiometer made by Dataphysics company, Germany; MAGNA-IR 560 E.S.P fourier transform infrared spectrometer made by Nicolet company, USA.

2.2 Methods

2.2.1 Asphaltene precipitation experiment in autoclave

The autoclave was cleaned with petroleum ether and evacuated, and then 70 mL dehydrated Gudong crude oil was injected into the autoclave (Fig.1). The autoclave was kept at 30 °C in an oil bath, and CO₂ was injected into the autoclave, and the volume of the autoclave was tuned to reach the required experimental pressure. After 72 h of contact of CO₂ with crude oil while being magnetically stirred, the oil was sampled from sample connection and then the asphaltene content in oil was measured.

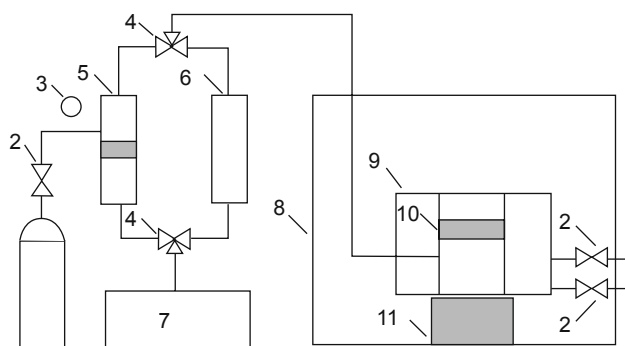

Fig. 1 Schematic diagram of asphaltene precipitation experimental apparatus

1-CO₂ bottle; 2-valves; 3-pressure gauge; 4-T-valves; 5-CO₂ boost pressure container; 6-crude container; 7-high-pressure pump; 8-oil bath; 9-autoclave; 10-piston; 11-magnetic stirring apparatus

2.2.2 Method for measuring the asphaltene content in oil samples

About 4.00 g oil sample was first filtered to remove the particles of suspended solids and impurities and weighed in a conical flask. Then *n*-hexane was added to the oil sample in the conical flask at the ratio of 40 mL *n*-hexane per 1.00 g crude oil, and the conical flask was placed in an ultrasonic cleaner (KQ2200 ShuFeng China) and oscillated for 20 min, and then left for 24 h. The sample was suction filtered using a 0.45 μm cellulose membrane, and the precipitates on the membrane were continuously washed with *n*-hexane until the effluent hexane became colorless. The obtained precipitates were then dried, weighed and the asphaltene content of the oil sample was obtained.

2.2.3 Measurement of interfacial tension between oil and water

The Wilhelmy plate method was used for measuring the interfacial tension between oil and water. The simulated oil was prepared from Gudong crude oil with refined kerosene and the kerosene to oil ratio is 4:1 by weight. The interfacial tension between simulated oil and distilled water was measured at 30 °C.

2.2.4 Calculation of the molar ratio of CO₂ and crude oil

The density of crude oil at desired temperature was measured by a densimeter, and the average relative molecular weight \bar{M} of crude oil was determined by Vapor Pressure Osmometry. The mole of crude oil with volume of V_0 is calculated as follows:

$$n_0 = \frac{V_0 \rho_0}{\bar{M}} \quad (1)$$

The compressibility factor (Z) of CO₂ at certain pressure and volume can be obtained using the diagram of general compressibility factors. The mole number (n_{CO_2}) of CO₂ injected in the autoclave was calculated as follows:

$$PV = Zn_{\text{CO}_2}RT \quad (2)$$

The molar ratio (r) of CO₂ and crude oil is expressed with Eq. (3):

$$n_{\text{CO}_2} = n_0 r \quad (3)$$

2.2.5 Methods for measuring core permeability and CO₂ core flooding

The core permeability was determined by using a core flooding apparatus shown in Fig. 2. The simulated sand core was placed in the core holder and a specific amount of fluid was injected. Then the equilibrium pressure at the entrance of the core holder was recorded and the core permeability was calculated by Darcy's Law.

The core was evacuated for 4 h and then saturated with water. The porosity and water permeability were measured. Then the core was dried to constant weight, and the weight was denoted as W_0 ; the weight of core after being saturated by oil was denoted as W_1 , then the weight of saturated oil was ($W_1 - W_0$). The core was flooded with oil and the oil permeability was determined, and then CO₂ was injected

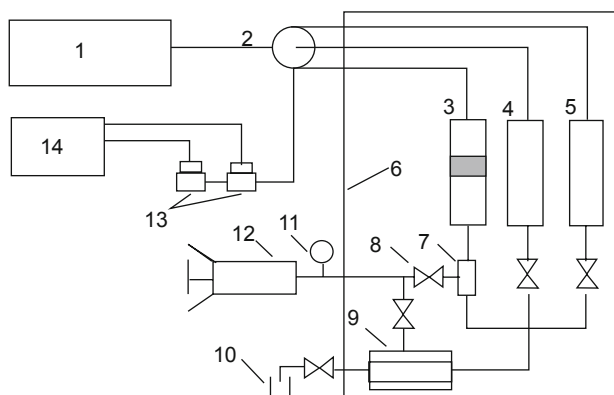

Fig. 2 Schematic diagram of measurement of core permeability and CO₂ flooding experimental apparatus

1-metering pump; 2-six joint valve; 3-CO₂ boost pressure container; 4-water container; 5-crude container; 6-air bath; 7-inverted valve; 8-valve; 9-core holder; 10-oil sample bottle; 11-pressure gauge; 12-hand pump; 13- pressure transducer; 14-data acquisition computer

until the pressure reached the set pressure. At this pressure, CO₂ interacted with crude oil for 24 h and then more CO₂ was injected at constant pressure and constant flow rate. The produced oil was collected to calculate the oil recovery by CO₂ flooding. After these steps, the oil permeability was measured again and the oil permeability before and after interaction with CO₂ was compared, and the asphaltene content of the produced oil was determined.

3 Results and discussion

3.1 Variation of interfacial tension between oil and water after crude oil interacted with CO₂

3.1.1 At different pressures

Crude oil was placed in an autoclave and interacted with CO₂. The molar ratio of CO₂ to oil is 3:1, under different pressures at 30 °C. After being interacted with CO₂, the oil sample was used to prepare simulated oil by 4:1 dilution with kerosene. The interfacial tension between simulated oil and distilled water with time at different pressures is shown in Fig. 3.

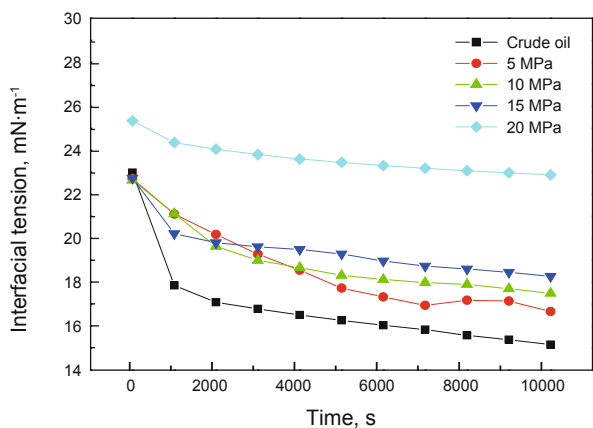

Fig. 3 Oil-water interfacial tension after crude oil contacted with CO₂ at different CO₂ pressures at 30 °C

Fig. 3 showed that compared with the initial crude oil, under the same condition of temperature and mole number ratio, the interfacial tension between simulated oil and water increased with the pressure of CO₂+crude oil system.

According to the micelle model of asphaltene and resins, crude oil is a stable colloidal dispersion system due to the existence of asphaltene and resins. In this dispersion system, the core of the dispersed phase is asphaltene, around which micelles are formed from part of the resins, and the remainder of the resins and the other components of crude oil form the dispersion medium. The stability of the colloidal system is closely related to the relative content and structure properties of the dispersed phase and the dispersion medium. These properties include aromaticity, viscosity and relative molecular mass etc. The variation of these above-mentioned factors would damage the stability of the colloidal dispersion system, resulting in the phenomenon of asphaltene precipitation (Yang and Lu, 2006).

Asphaltene molecules are more likely to associate with coexisting resin molecules before a precipitator was added, consequently a stable spatial layer formed due to the resin molecules being absorbed on the surface of the asphaltene kernel and the stable layer can prevent the association and coagulation of asphaltene kernels (Sun, 2004; Wang, 2008). However, spatial steric hindrance cannot prevent small molecules from moving close to the colloidal nucleus. After being dissolved in crude oil, the concentration of CO₂ in the dispersion medium increased. CO₂ molecules and asphaltene molecules are quite unlike in thermodynamics, and the dissimilar properties are mainly the large difference in the size and the polarity of their molecules. Therefore, with increasing concentration of CO₂ in the dispersion medium, the surface energy of the system increased greatly. To decrease the surface energy, the micelles became joined to one another so that the surface area could be decreased. The asphaltene began to precipitate as soon as the size of the micelles reached the critical value, which is also called the precipitation threshold of asphaltene. When the pressure of the autoclave increased, more CO₂ dissolved into oil phase, favorable to the association and precipitation of asphaltene. As asphaltene is one of the surface active materials in crude oil, a decrease of colloidal asphaltene can lead to an increase of the interfacial tension between water and oil.

3.1.2 At different temperatures

Crude oil is placed in an autoclave and interacted with CO₂ (the molar ratio of CO₂ to oil being 75%) at different temperatures at 15 MPa. After interaction with CO₂ the oil sample was used to prepare simulated oil by dilution with kerosene as above. The interfacial tension between simulated oil and distilled water with time at different temperatures is shown in Fig. 4.

It can be seen from Fig. 4 that compared with the untreated crude oil, which had not interacted with CO₂, under the same condition of pressure and CO₂ to oil molar ratio, the interfacial tension between simulated oil and water increased as the experimental temperature decreased. The reason was that at the same pressure, the density of CO₂, and the solubility of CO₂ in crude oil, increased with a decrease

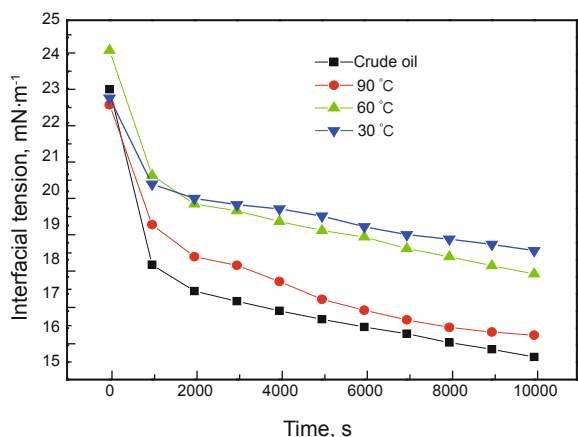

Fig. 4 Oil-water interfacial tension after crude oil contacted with CO₂ at different temperatures at 15 MPa

of temperature (Wang, 2008). According to the micelle model of asphaltene and resins, more asphaltene would precipitate from oil phase, consequently the asphaltene content in crude oil decreased and the interfacial tension between simulated oil and water increased.

3.1.3 At different molar ratios

At 30 °C and a pressure of 15 MPa, the crude oil was interacted with different amounts of CO₂, and then the oil sample was used to prepare simulated oil. The interfacial tension between simulated oil and distilled water with time is shown in Fig. 5

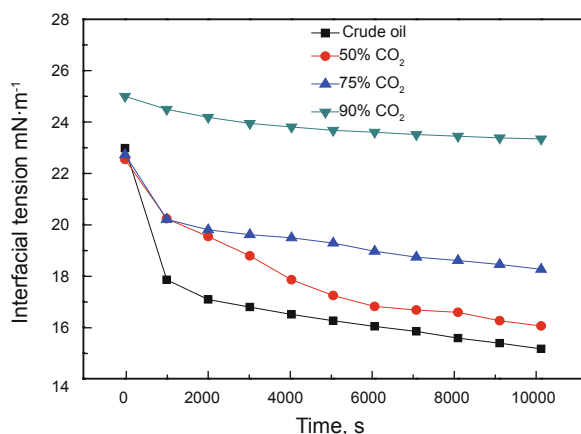

Fig. 5 Oil-water interfacial tension of crude oil contacted with different amounts of CO₂ at 30 °C and 15 MPa

From Fig. 5, it can be seen that compared with the untreated crude oil, which had not interacted with CO₂, under the same condition of pressure and temperature, the interfacial tension between simulated oil and water increased with an increase of CO₂ to oil molar ratio. The reason was that when the mole ratio of CO₂ to oil increased, more light components in crude oil were extracted into the CO₂ phase, and the content of the heavy components increased, causing an increased amount of asphaltene precipitation and subsequently the interfacial tension between simulated oil and water increased.

3.1.4 Variation of interfacial tension after asphaltene was removed from crude oil

To further investigate the effect of asphaltene precipitation

induced by CO₂ on the interfacial tension between oil and water, *n*-hexane was added in the crude oil to precipitate asphaltene and then the asphaltene precipitate was removed by suction filtration. The filtrate was treated by reduced-pressure distillation to remove *n*-hexane. The treated oil was used to prepare simulated oil with an oil to kerosene mass ratio of 20%. The interfacial tension between the simulated oil and distilled water with time was measured. For comparison, the oil-water interfacial tension of crude oil, which interacted with CO₂ for 72 h under the condition of 30 °C, 20 MPa and molar ratio of CO₂ of 0.75, was also measured. The result is shown in Fig. 6.

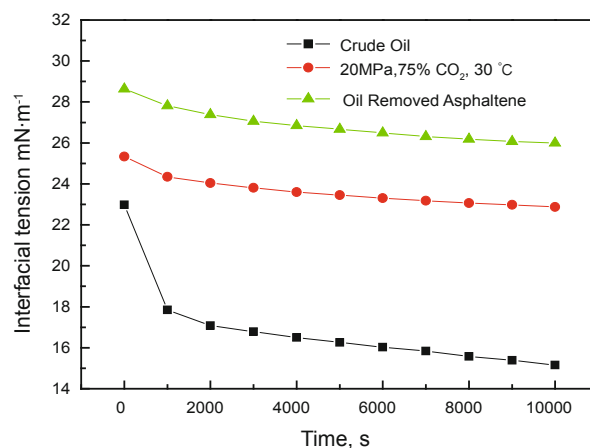

Fig. 6 Oil-water interfacial tension of crude oil with asphaltene removed

Fig. 6 showed that the oil-water interfacial tension of crude oil (with asphaltene having been removed) was larger than that of crude oil interacted with CO₂, and they both were larger than that of the untreated crude oil. The reason was that the existence of asphaltene and resins reduces the oil-water interfacial tension, and the oil-water interfacial tension tended to decrease with increasing content of asphaltene and resins. After crude oil interacted with CO₂, part of the asphaltene was precipitated, and the surface active materials decreased, resulting in an increase of the oil-water interfacial tension. When asphaltene was removed from crude oil, the oil-water interfacial tension became higher. The experimental results indicated that asphaltene precipitation induced by CO₂ can cause the oil-water interfacial tension to increase.

3.2 Variation of asphaltene content in crude oil after being interacted with CO₂

3.2.1 At different pressures

The experiment was carried out at 30 °C and a molar ratio of CO₂ to oil of 75%. Table 1 shows the asphaltene content of crude oil after it interacted with CO₂ for 48 hours at different pressures.

Table 1 Asphaltene contents of crude oil after it interacted with CO₂ at different pressures

Pressure of CO ₂ , MPa	0	5	10	15	20
Contents of asphaltene, wt%	4.89	4.86	4.80	4.32	3.68

Table 1 showed that when the pressure was lower than 10 MPa, the asphaltene content of crude oil did not change greatly; when the pressure was higher than 10 MPa, the asphaltene content decreased significantly. According to the micelle model of asphaltene and resins mentioned above, the CO_2 solubility in oil increased with pressure, and this was favorable to the association of asphaltene molecules to form precipitates. The stability of the colloid dispersion system was damaged by the change of the content of each component in crude oil, resulting in the phenomenon of asphaltene precipitation.

3.2.2 At different temperatures

The experimental condition was as follows: pressure was 15 MPa and the molar ratio of CO_2 to oil was 75%. Table 2 shows the asphaltene content of crude oil after it interacted with CO_2 for 48 hours at different temperatures.

Table 2 Asphaltene content of crude oil after it interacted with CO_2 at different temperatures

Temperature, °C	Crude oil	30	60	90
Contents of asphaltene, wt%	4.89	4.32	4.57	4.82

Table 2 showed that the asphaltene content in crude oil increased with the rise of temperature. This was because that the solubility of CO_2 decreased with the increase of temperature, and the effect of CO_2 on asphaltene decreased, resulting in a decrease of the amount of asphaltene precipitated. Consequently, the asphaltene content in crude oil increased.

3.2.3 At different molar ratios

The experiment was carried out at 30 °C and 15 MPa. Table 3 shows the asphaltene content of crude oil after it was interacted with different amounts of CO_2 for 48 hours.

Table 3 Asphaltene contents of crude after it interacted with CO_2 at different CO_2 to crude ratios

CO_2 to oil ratio, %	0	50	75	90
Contents of asphaltene, wt%	4.89	4.85	4.32	3.55

From Table 3, it can be seen that the asphaltene content in crude oil decreased with an increase of the molar ratio of CO_2 to crude oil. This was because when the relative content of CO_2 increased, more of the light components of crude oil were extracted into CO_2 phase, causing the increased asphaltene precipitation.

3.3 Variation of infrared spectroscopy absorption peak of crude oil after it interacted with CO_2

To investigate the change in components of crude oil after it interacted with CO_2 , the infrared spectrogram for crude oil samples at 30 °C, before and after interaction with CO_2 under different conditions, were recorded, and the results are shown in Fig. 7.

From Fig. 7, it can be seen that at the condition of 20 MPa and a CO_2 to oil molar ratio of 75%, the intensity of the absorption peak of crude oil at 1,629.46 cm^{-1} and 1,307.72

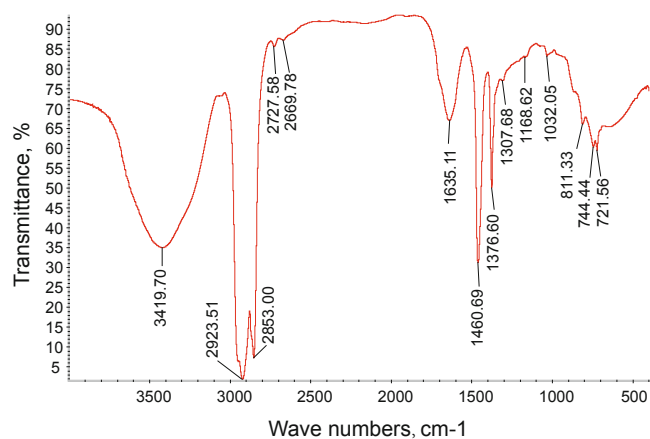

(a) Infrared spectrogram of crude oil

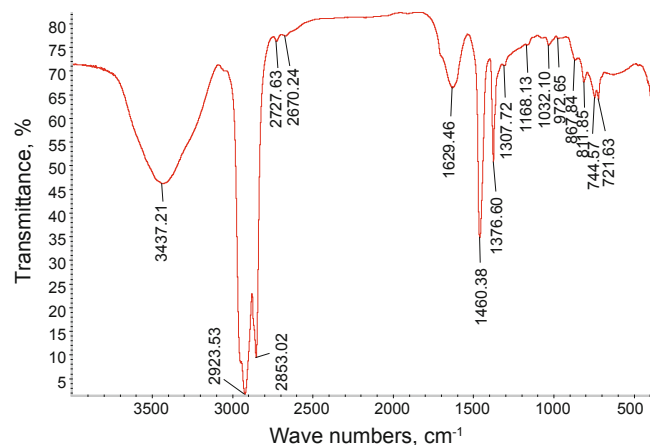

(b) Infrared spectrogram of oil sample after it contacted with CO_2 at CO_2 to crude oil ratio of 75% and 20 MPa

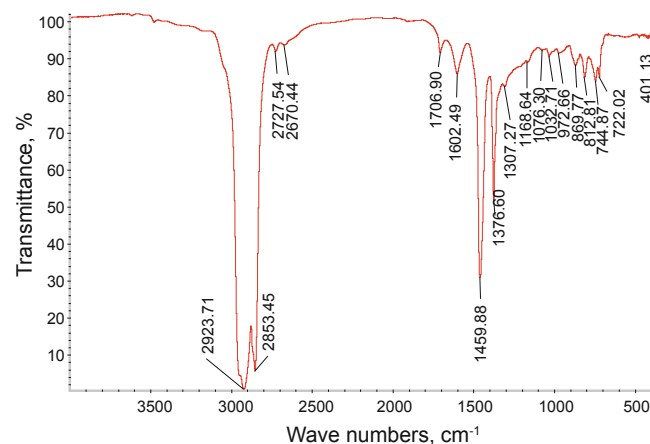

(c) Infrared spectrogram of oil sample after it interacted with CO_2 at CO_2 to crude oil ratio of 90% and 15 MPa

Fig. 7 Infrared spectrogram of different oil samples

cm^{-1} (Fig. 7b), after it interacted with CO_2 , was weak in comparison with that of initial crude oil at 1635.11 cm^{-1} and 1,307.68 cm^{-1} (Fig. 7a), respectively; At 15 MPa and a CO_2 to oil molar ratio of 90%, the intensity of the absorption peaks of crude oil at 1,706.90 cm^{-1} and 1307.27 cm^{-1} , after it interacted

with CO₂, were much weaker (Fig. 7c). The absorption peaks in the range of 1,755-1,670 cm⁻¹ are from the stretching vibration of carbonyl; The absorption peaks in the range of 1,320-1,210 cm⁻¹ are from the stretching vibration of C–O of carboxylic (Liu et al, 1999). Most oxygen in crude oil existed in asphaltene and resins in the form of carbonyl compounds such as aldehyde, ketone, ester and acid, especially in the form of carboxylic acid (Chu et al, 2003), The reason why the intensity of the absorption peak in Fig. 7b and Fig. 7c became weak was mainly the decrease of asphaltene and resin components.

Compared with the intensity of the absorption peaks of initial crude oil at 811.33, 744.44 and 721.56 cm⁻¹ (Fig. 7a), the intensity of absorption peaks of crude oil, which interacted with CO₂ at 20 MPa and a CO₂ to oil molar ratio of 75%, at 811.85, 744.57 and 721.63 cm⁻¹ (Fig. 7b), and that of crude oil, which interacted with CO₂ at 15 MPa and a CO₂ to oil molar ratio of 90%, at 812.81, 744.87 and 722.02 cm⁻¹ (Fig. 7c), were respectively weak. The absorption peaks in the range of 860-690 cm⁻¹ represent the bending vibration of C–H of aromatic compounds (Liu et al, 1999). From the basic structure of the asphaltene molecule, it appears that the fused aromatic nucleus forms the core of asphaltene molecules, with several naphthenic rings being connected to the core, and the main structure unit of the asphaltene molecule is the aromatic nucleus (Chu et al, 2003), therefore the reduction in the intensity of the absorption peak indicated a decrease of asphaltene content in crude oil.

3.4 Variation of elemental composition of oil before and after it interacted with CO₂

To investigate the variation of elemental composition of oil before and after it interacted with CO₂, an elemental analyzer (Vario EL cube, Elementar, Germany) was utilized for determining the elemental composition of oil samples. Oil sample 1 was obtained from crude oil interacted with CO₂ at 20 MPa and a CO₂ to oil molar ratio of 75% at 30 °C. Oil sample 2 was obtained from crude oil interacted with CO₂ at 15 MPa and a CO₂ to oil molar ratio of 90% at 30 °C. The results are shown in Table. 4.

Table 4 Elemental composition of oil before and after it interacted with CO₂

Sample	Elemental composition				
	C, %	H, %	S, %	N, %	O, %
Crude oil	84.46	12.19	0.65	0.77	0.70
Oil sample 1	86.06	12.16	0.45	0.67	1.28
Oil sample 2	85.70	12.16	0.34	0.66	0.71

Table 4 showed that after crude oil interacted with CO₂, the contents of S and N decreased, and the contents of S and N decreased with the increase of CO₂ to oil molar ratio. Most S, N and O of crude oil were in the structure of asphaltene and resin, as the heteroatom content of asphaltene and resin was higher than that of saturates and aromatics. Therefore it can be concluded that the reduction of S and N content was attributed to the precipitation of asphaltene and resin. Because

oxygen also exists in air and it is easily for crude oil to be oxidized, the real oxygen content of uncontaminated crude oil is difficult to determine. The reason for the apparent changes of oxygen content in crude oil is not clear.

3.5 Variation of core permeability induced by asphaltene precipitation during CO₂ flooding process

Previous research (Wang, 2008) showed that during the CO₂ flooding process, the wettability of the core can change because of the combined action of water and CO₂, subsequently resulting in an increase of the permeability of the core. To eliminate the effect of water on the permeability of core, the experiment was operated without water, by the same method as the CO₂ core flooding test. The cores used in our experiment is just sand. CO₂ was injected in the anhydrous core which had already been saturated with oil at 30 °C. The oil recovery and the oil permeability before and after CO₂ flooding were measured. The basic parameters of cores and the experiment results are shown in Table 5 and Table 6, respectively.

Table 5 Parameters of drill core and oil recovery by CO₂ flooding

Mark of drill core	Length cm	Diameter cm	Porosity %	K _w 10 ⁻³ μm ²	Recovery %
1-22	9.850	2.480	24.47	238.6	16.4
1-2	10.04	2.530	24.26	233.7	21.3
1-4	10.06	2.530	23.74	222.4	24.9
1-7	10.05	2.530	25.85	238.2	33.0

Notes: K_w stands for water permeability

Table 6 Variation in drill core permeability and asphaltene contents in oil after CO₂ flooding at different pressures

Mark of drill core	Pressure of CO ₂ flooding, MPa	K _o 10 ⁻³ μm ²	K _o ' 10 ⁻³ μm ²	Asphaltene contents of oil, %
1-22	5	49.0	44.8	4.87
1-2	10	48.0	39.8	4.82
1-4	15	46.4	25.9	4.71
1-7	20	47.8	21.2	4.60

Notes: K_o and K_o' are oil permeability before and after CO₂ flooding

Table 5 and Table 6 show that at the similar initial oil permeability, for the same amount of CO₂ injected, the oil recovery increased with an increase of displacement pressure; while the oil permeability after displacement decreased, the asphaltene content of produced oil decreased, and the amount of asphaltene precipitated increased with an increase of displacement pressure .

After crude oil interacted with CO₂ in the porous medium, asphaltene precipitation happened and the precipitate was adsorbed in the pores and blocked part of the pores, as a result, the permeability of core decreased. With an increase of displacement pressure, the amount of asphaltene precipitated increased, the asphaltene content of produced oil decreased

and the permeability of core decreased significantly. Therefore, during the process of CO₂ flooding, the interaction of CO₂ and oil would cause asphaltene precipitation, leading to the content of each component varying; meanwhile the asphaltene precipitated in the pores would decrease the permeability of the reservoir rock, thereby the flow of crude oil in reservoir was also affected.

4 Conclusions

1) The variation of interfacial tension between oil and water, the asphaltene content in crude oil, oil components and the elemental composition show that asphaltene precipitates after crude oil being interacted with CO₂.

2) When CO₂ and oil interact with each other, the amount of asphaltene precipitated increases with pressure and molar ratio of CO₂ to oil and decreases with temperature.

3) During the CO₂ flooding process, with the injection pressure being increased, the amount of asphaltene precipitated increases and the oil permeability decreases.

Acknowledgement

This work was supported by the National Key Technologies R & D Program (2012BAC24B02), Basic Subject Fund of China University of Petroleum-Beijing (KYJJ2012-07-01), Basic Subject Fund of China University of Petroleum-Beijing (No. YJRC-2013-20) and National Natural Science Foundation of China (51304222).

References

- Becker H L, Thomas D C, Dodderidge W R, et al. Asphaltene deposition control using chemical control agents. CIM Annual Technical Conference, 7-10 June 1992, Calgary (paper CIM 92-7)
- Buckley J S. Asphaltene Precipitation and Crude Oil Wetting. SPE Advanced Technology Series. 1995. 53
- Chu Y P, Hu Y F and Ming Y F. Experiment on precipitation amount and mechanism of asphaltene in high-pressure gas injection process. Journal of China University of Petroleum (Edition of Nature Science). 2003. 27(2): 74-77 (in Chinese)
- Kamath V A, Yang J and Sharma G D. Effect of asphaltene deposition on dynamic displacements of oil by water. Western Regional Meeting, 26-28 May 1993, Anchorage (paper SPE26046)
- Kokal S L and Sayegh S G. Asphaltenes: The cholesterol of petroleum. Middle East Oil Show, 11-14 March 1995, Bahrain (paper SPE 29787)
- Leontaritis K J and Mansoori G A. Asphaltene deposition: A survey of field experiences and research approaches. J. Pet. Sci Eng. 1988. 1: 229
- Leontaritis K J, Amaefile J O and Charles R E. A systematic approach for the prevention and treatment of formation damage caused by asphaltene deposition. SPE International Symposium on Formation Damage Control, 26-27 February 1992, Lafayette, Louisiana (SPE 23810)
- Li M, Sun L and Li S L. Mechanism and modeling technique of asphaltene precipitation. Journal of Southwest Petroleum Institute. 2000. 22(1): 9-11 (in Chinese)
- Li X L. Experimental studies on asphaltene precipitation with CO₂ miscible flooding in Fan124 block of Daluhu Oilfield. Journal of China University of Petroleum (Edition of Nature Science). 2006. 30(2): 64-68 (in Chinese)
- Lin S X. Petroleum Processing. Third Edition. Beijing: Petroleum Industry Press. 2000. 37-62 (in Chinese)
- Liu Z M, Yang G Y, Lu Y, et al. Phase equilibria of the CO₂-Jiangsu crude oil system and precipitation of heavy components induced by supercritical CO₂. Journal of Supercritical Fluids. 1999. 16: 27-31
- Novosad Z and Costain T G. Experimental and modeling studies of asphaltene equilibria for a reservoir under CO₂ injection. SPE Annual Technical Conference and Exhibition, 23-26 September 1990, New Orleans (paper SPE 20530)
- Shen E Y and Mullins O C (eds). Asphaltenes: Fundamentals and Applications. New York: Plenum Press. 1995. Chap. III. 97-113
- Srivastava R K, Huang S S and Dong M Z. Asphaltene deposition during CO₂ flooding. SPE Production & Facilities. 1999. 14(4): 235-245
- Sun F X. Instrumental Analysis. Beijing: Chemical Industry Press. 2004. 53-65 (in Chinese)
- Wang J. Study on Rules of Reservoir Property Changes Caused by CO₂ Flooding. Masters Dissertation. China University of Petroleum (Beijing). 2008 (in Chinese)
- Yang X L and Lu W Z. Study on interfacial properties of asphaltenes and resins from Liaohe crude. Acta Petrolei Sinica (Petroleum Processing Section). 2006. 30(5):1-6 (in Chinese)

(Edited by Zhu Xiuqin)